

Lincat

Installation, Operating, Servicing & Conversion Instructions

Opus 800 Gas Fryers

OG8110, OG8110/OP, OG8111, OG8111/OP,
OG8111/OP2, OG8106, OG8106/OP, OG8107,
OG8107/OP

Please make a note of your product details for future use:

Date Purchased: _____

Model Number: _____

Serial Number: _____

Dealer: _____

Opus **800**

CONTENTS

Important Information	2
Warnings and Precautions	3
Technical Data	4
Checklist of Enclosures	4
Installation and Commissioning	5-8
Operating Instructions	9-10
Cleaning	11
Servicing, Maintenance and Component Replacement	12-14
Conversion	15-16
Fault Finding	17-20
Spare Parts List	21
Accessories	21
Service Information and Guarantee	22
Notes	23-24

IMPORTANT INFORMATION



Read these instructions carefully before using this product, paying particular attention to all sections that carry warning symbols, caution symbols and notices. Ensure that these are understood at all times.



WARNING!

This symbol is used whenever there is a risk of personal injury.



CAUTION!

This symbol is used whenever there is a risk of damaging your Lincat product.

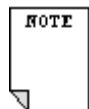

NOTE:

This symbol is used to provide additional information, hints and tips.



EQUIPOTENTIALITY

This equipment is provided with an equipotential bonding terminal to allow earth cross-bonding with other equipment.

KEEP THIS MANUAL FOR FUTURE REFERENCE

WARNINGS AND PRECAUTIONS



Only qualified or trained personnel should use this appliance.

Parts protected by the manufacturer shall not be adjusted by the user.

Do not leave the appliance unattended whilst operating.

Do not operate with dust cover in place.

Do not obstruct or block the flue.

If the supply cord is damaged, it must be replaced by the manufacturer, its service agent or similarly qualified persons in order to avoid a hazard.

All equipment must be earthed to prevent shock.

Disconnect the unit from the electricity supply before cleaning, servicing or undertaking any maintenance.

If this appliance is fitted with castors, use caution at all times when manipulating or moving, and lock castors when appliance is in position.

During operation parts may become hot - avoid accidental contact.

Install a suitable fire extinguisher and fire blanket within reach of the appliance.

Do not use flammable solvents and cleaning aids.

Strip plastic coating and clean the appliance before use.

This unit is designed to be used with oils and fats in a liquid form.

Oils and fats that become solid at lower temperatures must be liquefied prior to dispensing into the fryer tank.

On units with filtration the oil or fat used must also be liquid prior to operating the pump.

Old oil has a reduced flashpoint and is more prone to surge boiling.

Do not operate without oil in the tank.

Do not over heat the oil.

Care must be taken when replenishing the oil during service.

Oil should be filtered regularly.

This instruction includes both filling from empty and topping up during use.

TECHNICAL DATA

	OG8110	OG8111	OG8106	OG8107
Height (mm)	900	900	900	900
Width (mm)	400	600	400	600
Depth (mm)	800	800	800	800
Weight (kg)	70	102	92.6	105
Oil capacity (l)	14	28	16	25
Maximum frying weight	1 x 1.5kg	2 x 1.5kg	2 x 1.0kg	2 x 1.5kg
Gas inlet connection	½ G			
Gas pressure – Natural I _{2H}	13	13	14	14
Gas pressure – Propane I _{3P}	22	22	25	25
Heat input (Gross) – Natural I _{2H}	16kW (54,600 Btu)	32kW (109,200 Btu)	23kW (78,500 Btu)	30kW (102,400 Btu)
Heat input (Gross) – Propane I _{3P}				
Injector size (mm) – Natural I _{2H}	2.2 (220)	2.2 (220)	2.7 (270)	3.0 (300)
Injector size (mm) – Propane I _{3P}	1.55 (155)	1.55 (155)	1.75 (175)	2.0 (200)
Gas rate – Natural I _{2H}	1.52 m ³ h ⁻¹	3.05 m ³ h ⁻¹	2.19 m ³ h ⁻¹	2.86 m ³ h ⁻¹
Gas rate – Propane I _{3P}	1.14 kg h ⁻¹	2.29 kg h ⁻¹	1.64 kg h ⁻¹	2.14 kg h ⁻¹
Supply pressure – Natural I _{2H}	20			
Supply pressure – Propane I _{3P}	37			

These appliances are designated Category I and category II (II_{2H3P})

Connections							
Connection				Location			
Size		½ R _c (1/2" BSP)		LOWER REAR			
Volts	230	Phase	Single	Amps	4.9	Hz	50-60
Connection		3 Pin Plug		Location		RH Lower Rear	

CHECK LIST OF ENCLOSURES

All Units:					
Warranty card					
Instructions manual					
Baskets – OG8110 x 1, OG8111 x 2, OG8106 x 1, OG8107 x 2					
Batter plate					
Drain Bucket					
Legs / Castors					
Leg spanner (with leg kit only)					
Stabilising kit					
Filtration Units only:					
	OG8110/OP	OG8111/OP	OG8111/OP2	OG8106/OP	OG8107/OP
Filter Bag	1	1	2	1	1
Filter Bag Frame	1	1	2	1	1
Stainless Steel Filter	1	1	2	1	1
Oil Return Lance	1	1	2	1	1
Oil Return Hose	1	1	2	1	1

INSTALLATION AND COMMISSIONING

This appliance must be installed, commissioned, serviced and converted by a qualified person in accordance with national and local regulations in force in the country of installation.

Site this appliance beneath an extraction canopy for the removal of combustion products.

When making the gas connection, fit an isolating cock into the supply line close to the appliance for emergency shutdown or servicing purposes.

Installation must include sufficient ventilation to prevent the occurrence of unacceptable concentrations of substances harmful to health in the room of installation. There must be a minimum free area of 4.5cm² per kW of total heat input.

Allow for a sufficient flow of fresh air for complete gas combustion.

Do not connect directly to any flue, ducting or mechanical extraction system.

The gas supply hose or tubing shall comply with national requirements in force and shall be periodically examined and replaced as necessary. If flexible hose is used, secure the appliance to the wall with a chain.

A clear space of at least 100mm must be left to the rear of the appliance and 600mm to the front to allow for safe operation.

Install this appliance on a level surface ensuring all vents are unobstructed. Any partitions, walls or furniture must be of non-combustible material.

Gas supply and connection

Check that the gas supply corresponds to that specified on the data plate.

Connection is at the rear of the unit via a ½ G female thread. The gas supply tubing or hose shall comply with the national requirements in force and shall be periodically examined and replaced as necessary.

An isolating cock should be fitted into the supply line close to the unit for emergency shutdown or servicing purposes.

Fitting the Stabilising Kit (Fig 1)

The stabilising kit must be fitted to prevent accidental toppling of the appliance and to ensure a safe working environment.

Fit the adjustable stabiliser centrally to the underside of the front cross member of the appliance (A) using the M5 x 16 hex screws and shake proof washers provided. Ensure the tongue of the bracket is facing rearward and adjusted to sit just off the floor(C).

Position the appliance in the intended place. Place the floor plate (D) on the floor so that it fits over the tongue of the stabiliser. Mark locating hole positions of the floor plate. Drill out holes and fit supplied rawlplugs.

Screw the floor plate in position using 12g screws.

Adjust height position (B) of stabiliser tongue if necessary.

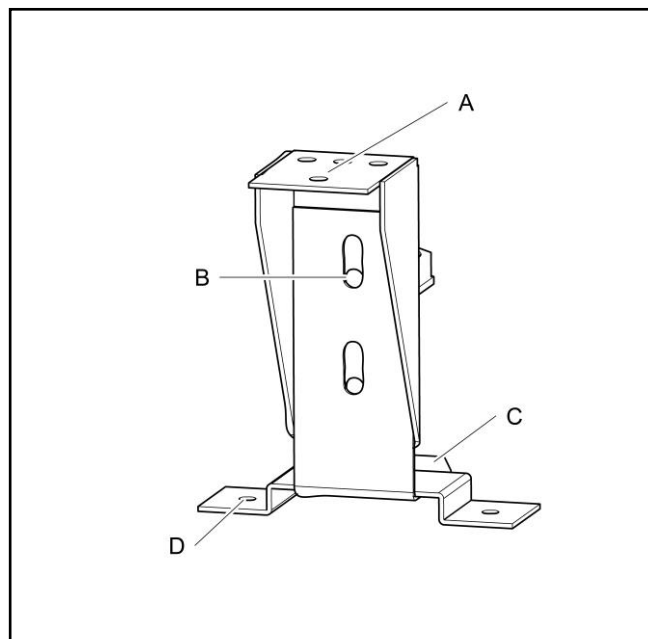

Fig 1

On the filtration units the following must be observed:

If the supply cable is damaged it should be replaced by Lincat Ltd or other suitably qualified persons, in order to avoid a hazard.

For safety regulations the plug or means of disconnection must always be accessible.

This unit must be earthed.

This unit is supplied with a 10 amp plug. If replacing the plug, connect the terminals as follows:

Green and yellow wire	Earth	E
Blue wire	Neutral	N
Brown wire	Live	L

Commissioning

Ensure that the oil drain valve is closed and clean the tank with a warm, mild detergent solution. Rinse the tank and dry.

Run a small quantity of oil across the base of the tank and allow it to drain to remove all traces of water and to provide the base of the tank with a coating of oil.

Close the drain valve. Fill the tank with oil to the low level marker on the batter plate.

Pressure setting (Fig 2)

Use the test point provided on the gas control to check the inlet pressure (I) and to set the appropriate burner pressure (J).

Adjustment is made via the valves on board governor, situated centrally on the valve (K). Remove the governor cap and turn the screw clockwise to increase outlet pressure, anticlockwise to reduce it.

After setting, ensure the governor cap is properly secured.

With main burner lit, adjust to the appropriate burner pressure.

Note: An external regulator should be fitted to the appliance only if the inlet pressure exceeds 50mbar.

Operational check

Light the appliance several times as per instructions, checking for correct and smooth ignition.

Operate the thermostat knob several times and observe that the burner ignites smoothly and without delay.

Set the thermostat to 190°C and allow the oil to heat up. Check the oil temperature 25mm below the surface in the geometric centre of the tank.

Ensure that the end user understands how to light, operate, shutdown and clean the appliance, and is aware of the position of the gas isolating cock.

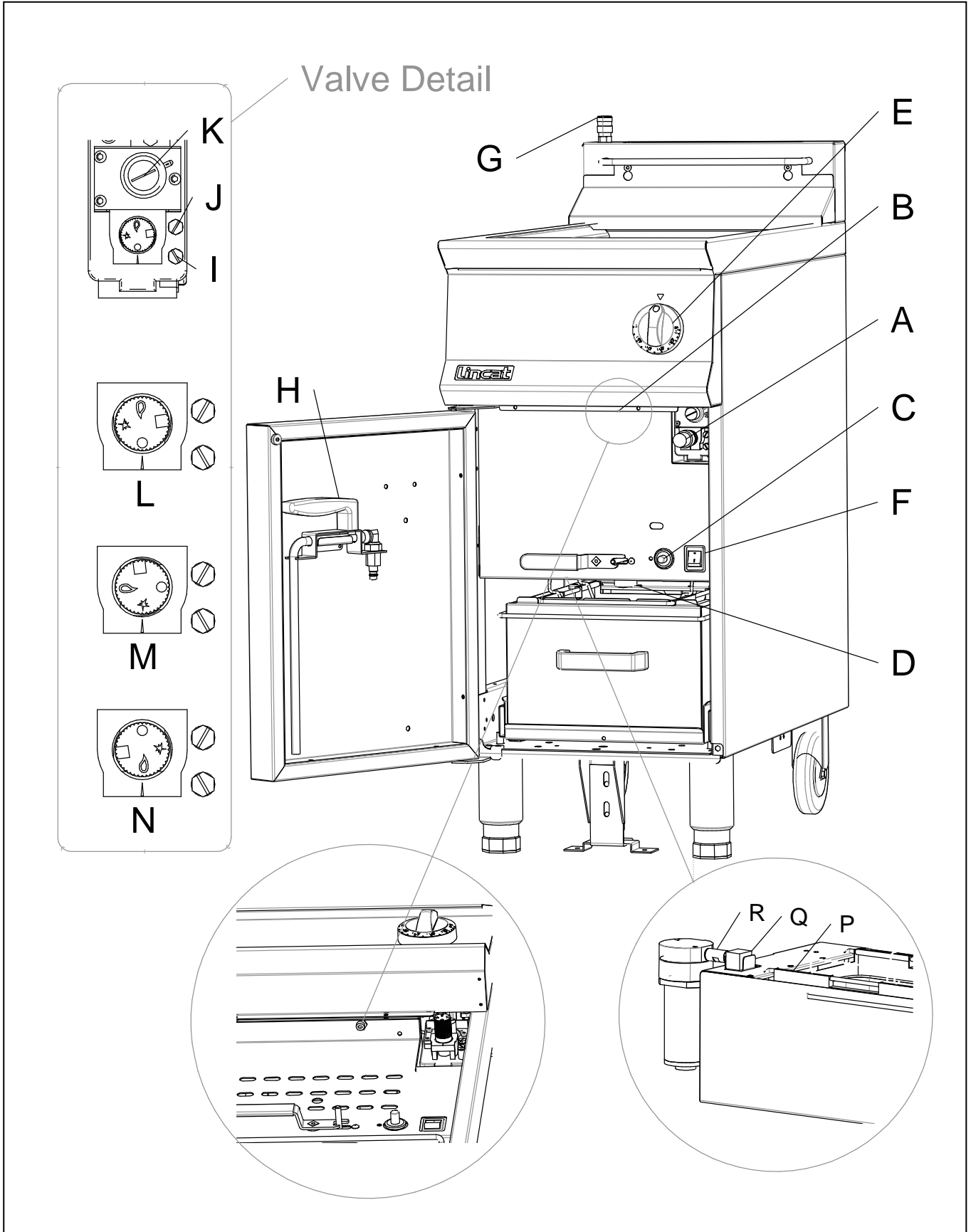

Fig 2

OPERATING INSTRUCTIONS

This appliance is for professional use and must be operated by qualified or trained personnel only.

This unit is intended to be used to produce deep fried products only.

General advice

For maximum efficiency, do not overload the baskets with product as it will result in reduced recovery times, uneven cooking and increased risk of surge boiling.

Always drain product before frying. Ensure water is never introduced into the oil as this will cause splashing and possible overflow from the tank.

Filling with oil

Remove and store the dust cover.

Check the drain valve is closed and fill with good quality oil to the low level mark on the batter plate. (Maintain oil at the upper level mark during use).

Lighting sequence (Fig 2)

Ensure the thermostat dial is turned to the 'Off' position (E).

Open the door to gain access to the gas control valve (A).

Rotate the valve knob to the Pilot position (M) Press and hold.

Ignite the pilot by pressing the piezo igniter (C). Operate until a pilot flame can be seen through the viewing port.

After ignition, hold the knob depressed for 20-30 seconds to establish the pilot flame. Release the knob and turn anticlockwise to the main burner position (N).

To operate the main burner, turn the thermostat control knob (E) to the required temperature.

Note: The gas control valve is fitted with a step opening ignition device which reaches full rate after approximately 10 seconds. There is also a start interlock device which prevents the appliance from re-igniting until the flame supervision device has interrupted the gas flow. After this stage it is possible to re-ignite the appliance.

Standby

To turn the appliance to standby, turn the thermostat control knob (E) to the 'Off' position.

Shutdown

To turn the appliance off completely, turn the thermostat control knob to the 'Off' position, then slightly depress the gas control valve knob (A) and rotate to the 'Off' position (L). Turn off at the mains cock.

Note: Should the safety cut out thermostat operate during use, the appliance will shut down. To re-light the appliance, allow the oil to cool and reset the thermostat by pressing the red button (B) located underneath the control panel.

Filtration models only:

Ensure that the filtration bag and frame (P) and the suction pipe (Q) correctly fitted and secured in the oil bucket and that the bucket is engaged in the pump connection (R).

Drain the oil and close the drain valve as previously explained.

Securely connect the oil return lance (H) into the connector (G).

Operate the pump run switch (F) until the oil has returned to the fryer tank then turn off the pump run switch.

Remove (H), clean and place back in the door bracket.

CLEANING



Do not use a water jet or steam cleaner, and do not immerse this appliance.

Turn the appliance off and isolate from the gas supply.

Ensure the drain container is in place.

To open the tap slide the latch (A) to the right and rotate the handle from position (B) to position (C) (Fig 3).

Once drained, close the tap to position (B) and the latch (A) will engage to prevent accidental opening.

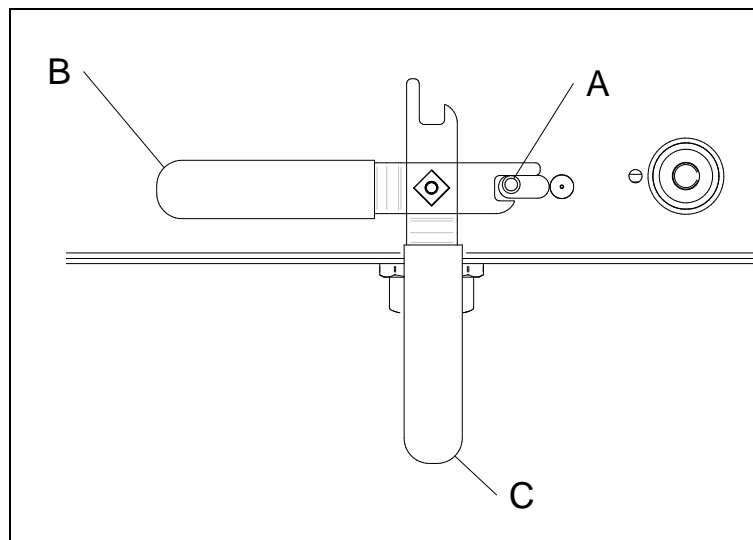

Fig 3

Wash the tank using a warm detergent solution.

With the drain tap open, clean using a suitable drain brush.

Dry all parts thoroughly and then flush tank, drain valve and elbow through with a small quantity of cooking oil to remove residual water.

Clean all surface panels with warm water and mild detergent do not use abrasive materials. Dry with a soft cloth.

The baskets, batter plates, drain bucket and filter mesh (Filtration units only) can be cleaned in a dishwasher.

SERVICING, MAINTENANCE AND COMPONENT REPLACEMENT

All servicing, maintenance and component replacement on this appliance should be carried out by one of our recommended service engineers.

Routine Service

Check the installation, specifically the hose type and condition, the installation of a safety chain and the installation of a separate isolation valve.

Check the burner operation, observing flame picture. Look for evidence of debris or damage. Remove burner and clean or replace as necessary. Check burner pressure as detailed in Commissioning section. Adjust if necessary.

Check injectors and clean or replace if necessary. Use nylon bristled brush and not reamers or wire which may affect orifice size.

Clean and check operation of the pilot assembly – check and adjust if required the alignment of the electrode and thermocouple.

Ensure the flue is clear.

Carry out a gas soundness check.

Component replacement

Before any of the following, ensure appliance is disconnected from supply.

Remove the lower cover to carry out the following work:

Burner injectors

Access from behind the manifold and remove and replace using a 12mm spanner.

Burners

Undo the 12mm fitting at the manifold inlet.

Undo the screws holding the manifold to the burners. Remove the manifold.

Undo the screws from the burner flange and remove the burners.

Reverse the above to reassemble.

Pilot assembly

Remove deflector plate below the pilot assembly.

Undo the pilot feed pipe from the pilot body taking care not to lose the injector.

Undo the electrode, thermopile and thermocouple.

Remove igniter cable from electrode.

Undo the two screws holding the pilot body to the chassis.

Reverse the above to reassemble.

Thermocouple

Remove the control knob. Open the doors and undo the screws beneath the facia panel. Undo the screws holding the thermostat. Remove the facia panel.

Undo the nut holding thermocouple to control valve.

Undo nut securing thermocouple to pilot body and pull down.

Replace the thermocouple and reverse procedure to reassemble.

Thermopile

Remove the facia panel as detailed above.

Undo the screws holding the thermopile connections to the control valve.

Release the retaining nut and draw the thermopile clear of the pilot body.

Replace thermopile and reverse procedure to reassemble.

Control thermostat

Drain the tank. Undo the screw holding the cover within the tank and slide off. Undo the nuts and release the bracket to ease removal of the thermostat bulb.

Remove the control panel as detailed earlier. Disconnect the two wires from the control thermostat.

Release the gland nut and withdraw the thermostat bulb, there will be resistance due to the packing behind the gland nut having been compacted.

Withdraw the thermostat, replace and reassemble by reversing the procedure.

Safety thermostat

Drain the tank. Undo the screw holding the cover within the tank and slide off. Undo the nuts and release the bracket to ease removal of the thermostat bulb.

Remove the control panel as detailed earlier.

Release the gland nut and withdraw the thermostat bulb, there will be resistance due to the packing behind the gland nut having been compacted.

Disconnect interrupter cables and remove the nut holding the thermostat to the chassis.

Reverse the above to reassemble, ensuring bulb and capillary are not damaged when installing.

Control valve

Disconnect the gas supply, burner feed and pilot pipes from the valve.

Disconnect thermocouple, thermopile and thermostat connections.

Remove the screws securing the valve to the chassis.

Remove the brass fittings from the old valve and reuse them on the new valve – NB valves are not supplied with brass fittings.

Reverse the above to reassemble. Check for soundness.

CONVERSION

This appliance cannot be converted by the user.

For a conversion kits contact the manufacturer whose details may be found in the service section of this manual.

This conversion must be carried out by a Gas Safe Certified engineer

Conversion of Gas Type

Convert to Model:	OG8110/N CKN67	OG8110/P CKP67	OG8111/N CKN68	OG8111/P CKP68
Burner Jets	2 x JE88 (220)	2 x JE89 (155)	4 x JE88 (220)	4 x JE89 (155)
3/8 BSP Washer	2 x WA13	2 x WA13	4 x WA13	4 x WA13
Cross-light Jet	1 x JE31 (26N)	1 x JE32 (LP16)	2 x JE31 (26N)	2 x JE32 (LP16)
Pilot Jet	1 x JE86 (51)	1 x JE87 (35)	2 x JE86 (51)	2 x JE87 (35)
Serial Plate	Nat Gas G20	Propane G31	Nat Gas G20	Propane G31
Gas Ident Label	"NATURAL"	"PROPANE"	"NATURAL"	"PROPANE"
Regulator Spring		1 x SP65		1 x SP65

Convert to Model:	OG8106/N CKN69	OG8106/P CKP69	OG8107/N CKN70	OG8107/P CKP70
Burner Jets	2 x JE277 (270)	2 x JE278 (175)	2 x JE97 (300)	2 x JE98 (200)
3/8 BSP Washer	2 x WA13	2 x WA13	2 x WA13	2 x WA13
Pilot Jet	1 x JE86 (51)	1 x JE87 (35)	1 x JE86 (51)	1 x JE87 (35)
Serial Plate	Nat Gas G20	Propane G31	Nat Gas G20	Propane G31
Gas Ident Label	"NATURAL"	"PROPANE"	"NATURAL"	"PROPANE"
Regulator Spring		1 x SP65		1 x SP65

Burner Injector replacement

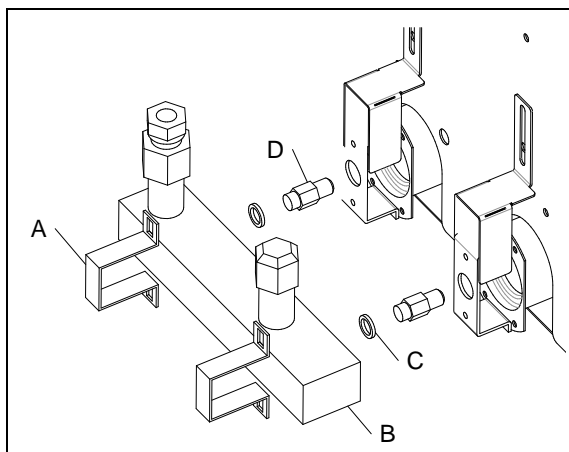

Undo the screws securing the cover plate and remove. Undo the screws holding the brackets 'A' and remove. Withdraw the manifold 'B' from the burners to allow removal of the injectors 'D'. Replace injectors and fit new copper washers 'C'. Reassemble in reverse order.

Pilot Injector replacement

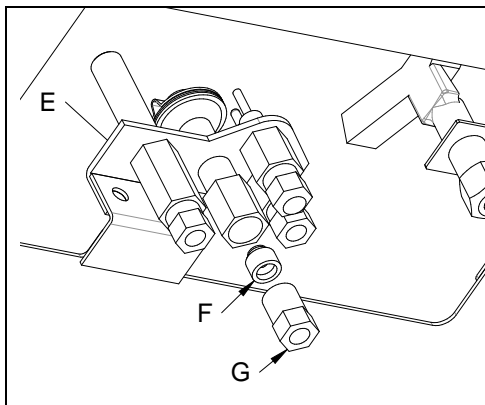

Remove the cover plate as above. Undo the screws supporting the splash guard and remove to gain access to the Pilot assembly 'E'. Undo the pilot feed pipe nut 'G' and pull the pipe from the body. Remove and replace with the appropriate injector and reassemble in reverse order.

Cross-Light Injector replacement (OG8110 & OG8111 models only).

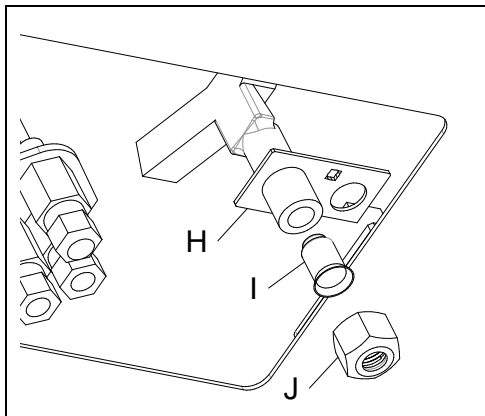

Remove the cover plate as above. Undo the screws supporting the splash guard and remove to gain access to the Cross-light assembly 'H'. Undo the feed pipe nut 'J' and pull the pipe from the body. Remove and replace with the appropriate injector and reassemble in reverse order.

Propane spring replacement

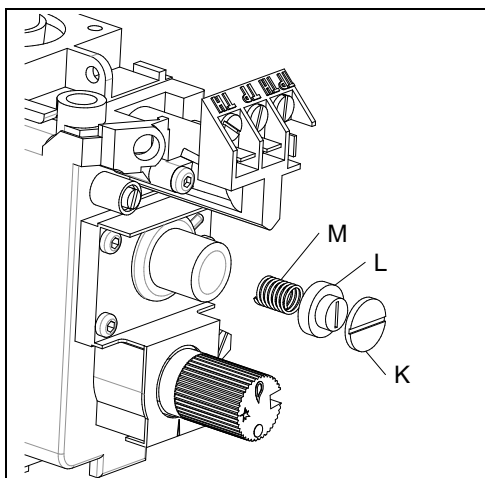

Unscrew the cap 'K' and the adjuster 'L'. Carefully replace the spring 'M' with the supplied spring 'SP65'. Reassemble in reverse order taking care to ensure correct engagement with the spring and the internal diaphragm.

FAULT FINDING

Explanation of the control system

The gas circuit of this appliance is controlled by two millivolt systems.

The first consists of an interrupted thermocouple, the pilot burner and the gas control. Heat from the pilot flame acting on the thermocouple generates a 15-20mV electrical potential. This operates the first solenoid on the gas control, allowing gas to the pilot. The safety thermostat is included in this system which operates via the interrupted thermocouple. The first solenoid acts as the safety device which shuts down in the event of a thermocouple failure or if the safety thermostat goes open circuit.

The second millivolt system consists of a thermopile acting through the gas control via the control thermostat. Heat from the pilot flame acting on the thermopile generates a 500-700mV electrical potential. This millivolt system connected to the gas control operates the secondary solenoid, allowing gas to the main burner. The system is interrupted by the control thermostat as it cycles, thereby opening and closing the gas supply to the burners.

The following flowcharts are designed to give assistance on the most probable source of failure.

Piezo igniter not sparking

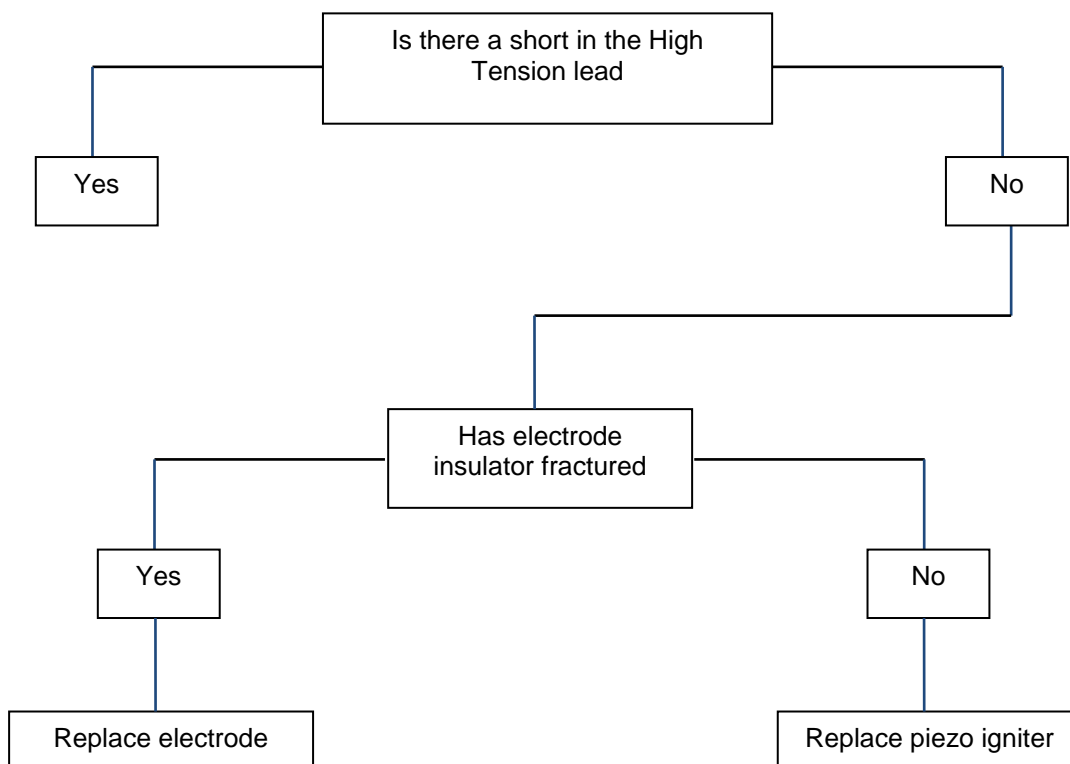

Pilot burner will not light or stay lit

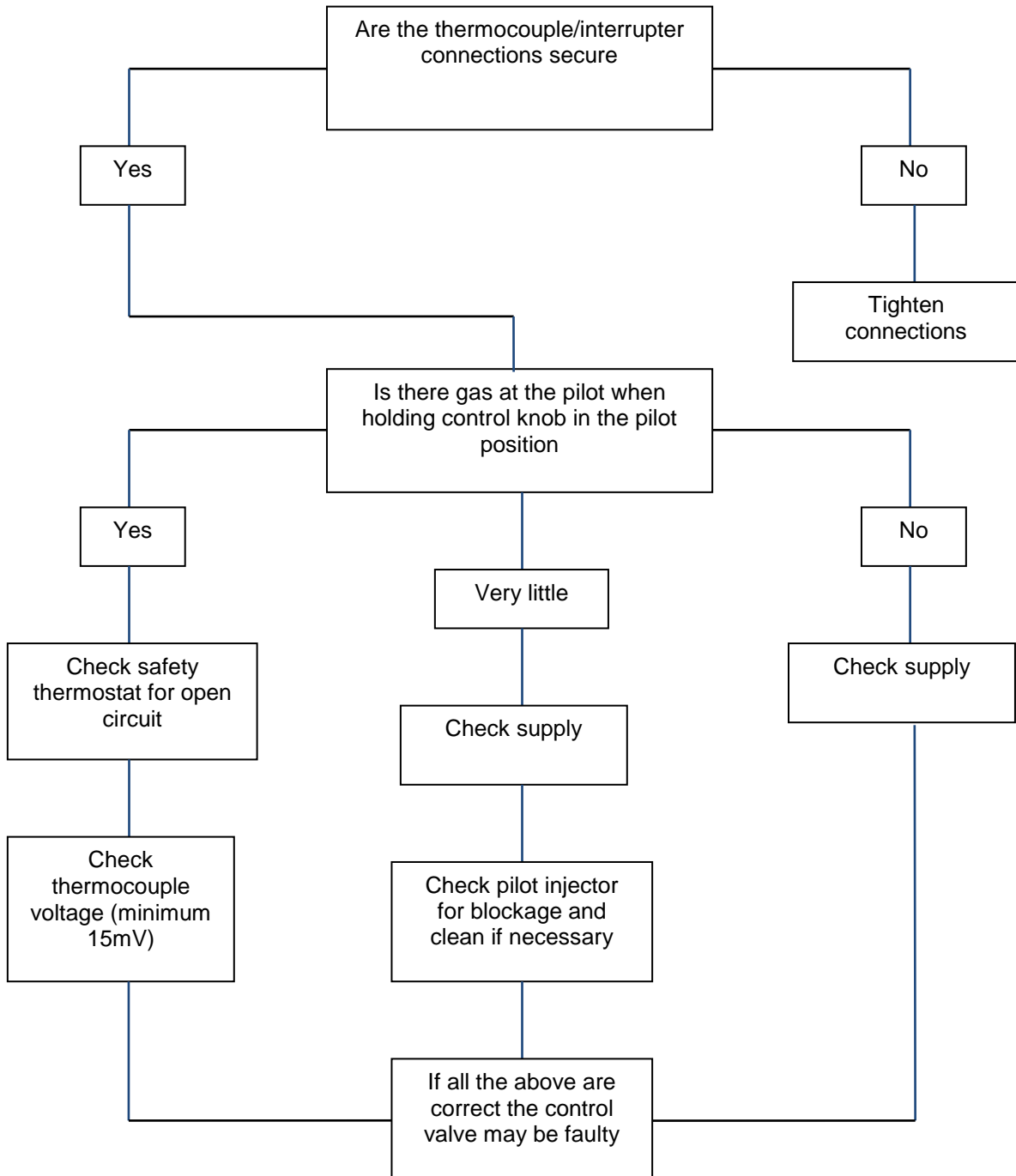

Main burner will not light

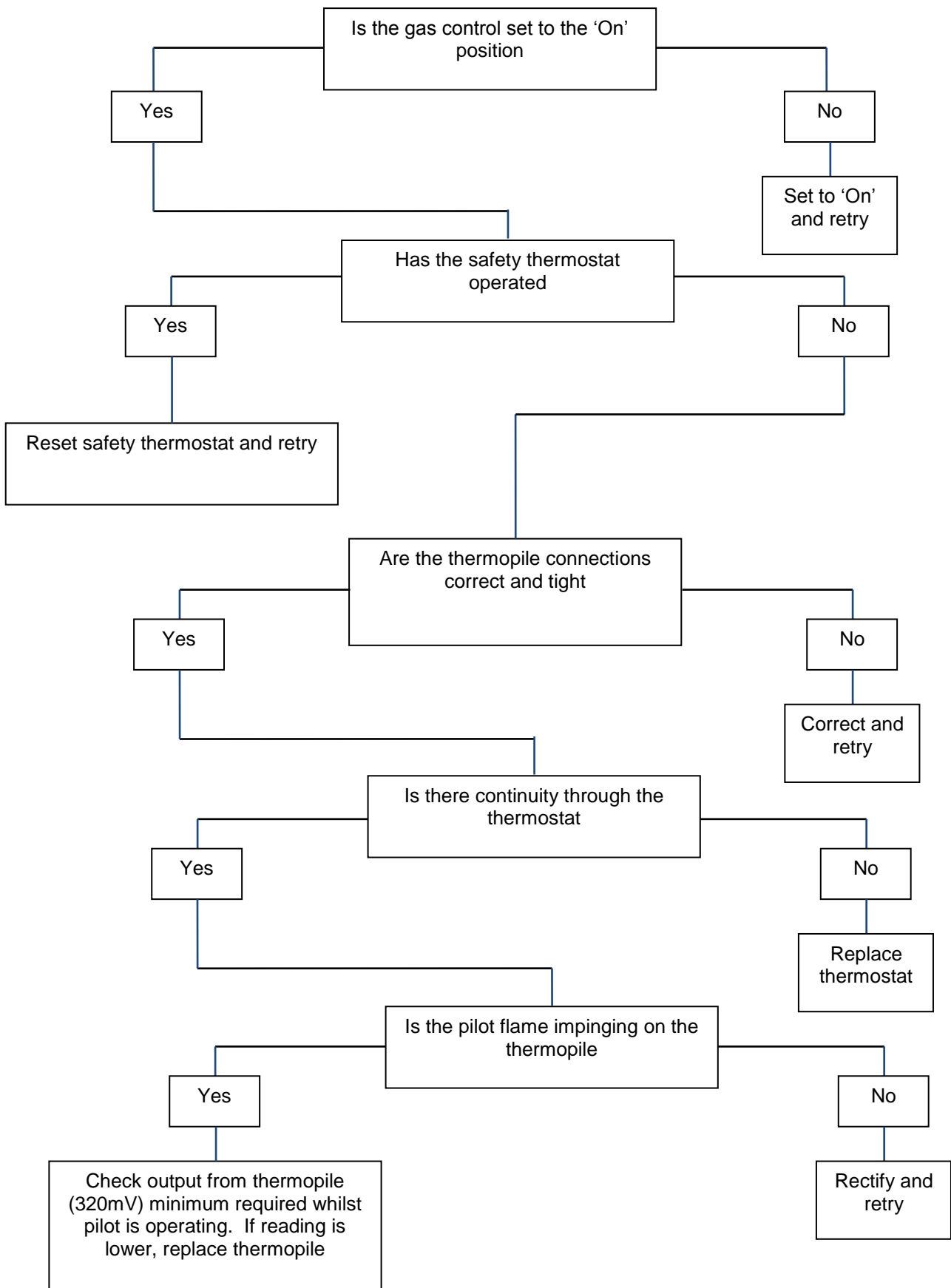

Safety thermostat operates

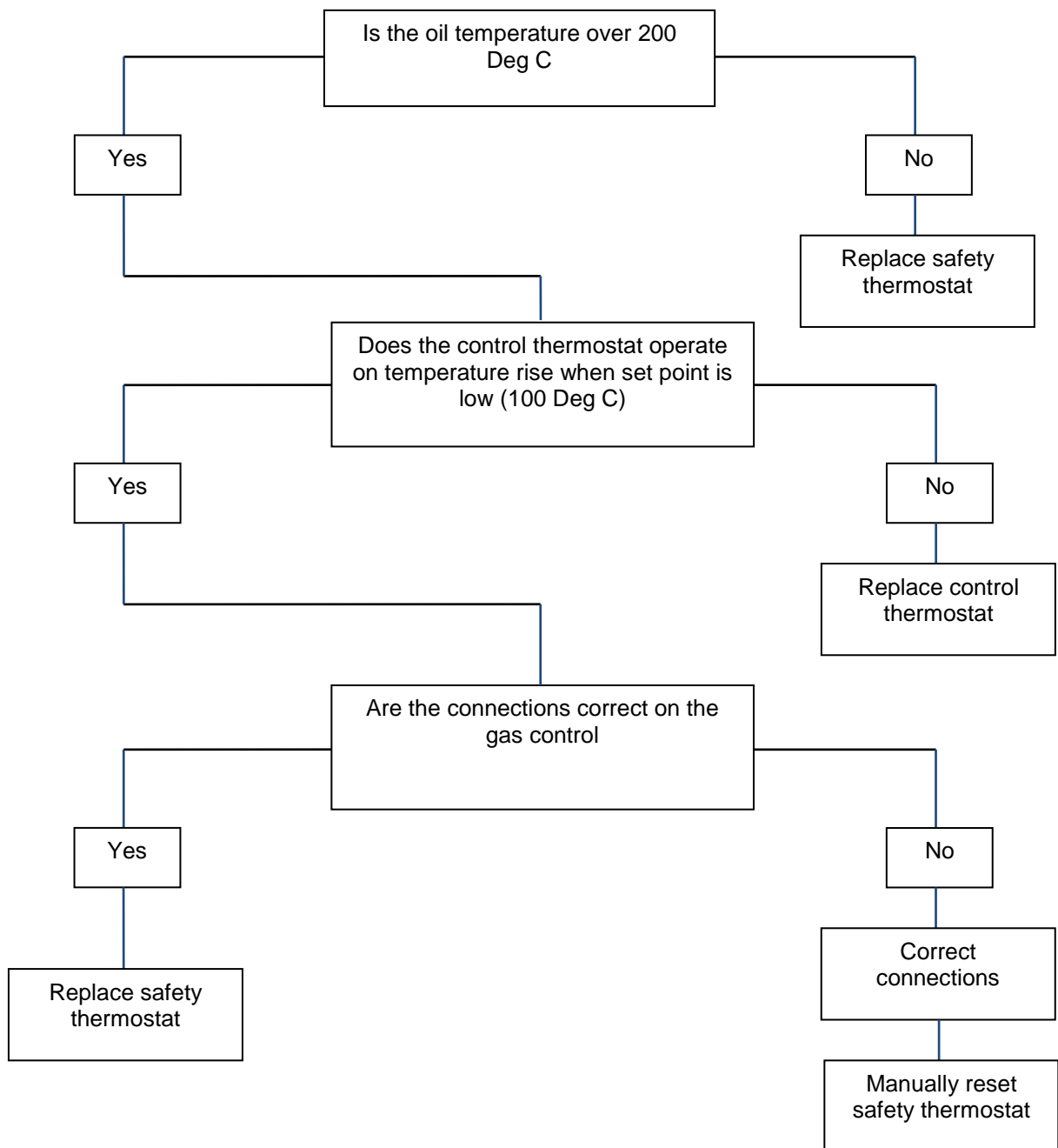

SPARE PARTS LIST

Part Number	Description
BA165	Basket OG8110, OG8111
BA82	Basket OG8106, OG8107
BA159	Half Basket OG8106, OG8107
BS27	Basket support OG8106
BS26 – BS28	Basket support OG8110, OG8111
BS28	Basket support OG8107
BU248	Burner OG8110, OG8111
BU250	Burner OG8106, OG8107
FZ401101	Drain valve
IG15	Igniter electrode
IG35	Piezo igniter
IG37	Igniter earth lead
IG39	Ignition lead
IN08	Interrupter Block
KN501	Control knob
LE37	Leg
PI08	Pilot body
TC51	Thermocouple
TC20	Thermopile
TH59B	Encapsulated Control thermostat
TH129B	Encapsulated Safety thermostat
VA20	Control valve
Filtration Models only:	
FZ214013	Oil Pump
FZ214026	AC-DC Transformer
FZ101142	Filter Bag Support OG8110, OG8111
FZ101143	Filter Bag Support OG8106, OG8107
FZ101158	Filter Bag OG8110, OG8111
FZ101159	Filter Bag OG8106, OG8107

ACCESSORIES

Part Number	Description
OA8954	Splashguard
OA8955	Splashguard

SERVICE INFORMATION

For help with the installation, maintenance and use of your **Lincat** equipment, please contact our service department:

☎ UK: 01522 875520

For non-UK customers, please contact your local Lincat dealer

All service work, other than routine cleaning **MUST** be carried out by qualified personnel and a record kept of any remedial actions taken and at least cover the requirements of the service schedule of this document. We cannot accept responsibility for work carried out by other persons.

To ensure your service enquiry is handled as efficiently as possible, please tell us:

- Brief details of the problem
 - Product code
 - Type number
 - Serial number
- } All available on serial plate

Lincat reserve the right to carry out any work under warranty, given reasonable access to the appliance, during normal working hours, Monday to Friday, 08:30 to 17:00.

DECLARATION

All Lincat products capable of burning gaseous fuels, satisfy the requirements of the Gas Appliance Regulations 2016/426.

GUARANTEE

This unit carries a comprehensive UK mainland warranty. The guarantee is in addition to, and does not diminish your statutory or legal rights. Contact Lincat for terms and conditions

The guarantee does not cover:

- Accidental damage, misuse or use not in accordance with the manufacturer's instructions
- Consumable items (such as filters, glass, bulbs, slot toaster elements and door seals.)
- Damage due to incorrect installation, modification, unauthorised service work or damage due to scale, food debris build-up, etc.

The manufacturer disclaims any liability for incidental, or consequential damages. Attendance is based on reasonable access to the appliance to allow the authorised personnel to carry out the warranty work.

Service calls to equipment under warranty will be carried out in accordance with the conditions of sale. Unless otherwise specified, a maximum of 15 minutes of administrative time, not spent directly carrying out servicing work, is provided for within the warranty. Any requirement for staff attending the call to spend more than 15 minutes due to administrative requirements, such as on health and safety risk assessments, will be chargeable at the prevailing rate.

Notes

Notes